



5/3/2019

Thank you for taking the time to consider a columbarium installation here in Winamac.

The cremation rate in the U.S. is rapidly increasing. Indiana has maintained full burials as the majority of end of life decisions, but the majority will soon be cremation if current rates continue.

Although cemeteries allow memorialization of cremated individuals on standard grave plots, the cost of the grave and memorial can be a deterrent to those arranging for their loved one's final disposition. The challenge at hand for communities and cemeteries is finding ways to memorialize our families, friends, and neighbors at a reasonable cost; so we can maintain historical and genealogical records for future generations. A columbarium fulfills this challenge.

A columbarium is a permanent structure built to house cremated remains and memorialize individuals that have chosen cremation for their end of life disposition. The structure must be solid and withstand weathering elements over time. The columbaria presented in this packet will do so.

Included in this packet you will find several different options of columbaria. We chose to include a variety in this packet to give the board several options and inform you of different types.

While there are many avenues available for purchasing a community columbarium, we feel it is important to consider who you are purchasing the columbarium through, the history of the organization, specific expertise, and long-term support.

Patten Monument was founded in 1917 as a monument company. As the cremation rate has risen we have been involved supplying dozens of columbaria around the states of Indiana, Michigan, and Ohio. The longevity of our company speaks for the quality and passion of memorialization. We stand behind our products 100%. Our confidence in standing behind our products comes from our emphasis of quality and extensive knowledge of the granite and products we provide.

We will happily provide references of our previous work and other individuals, townships, and communities we have worked with in the past.

Thank you for your consideration!



Proposal for Cemetery Columbarium

Winamac, IN

For consideration at the May 13th Board Meeting

*Image is for concept & unit design only see description for colors quoted.

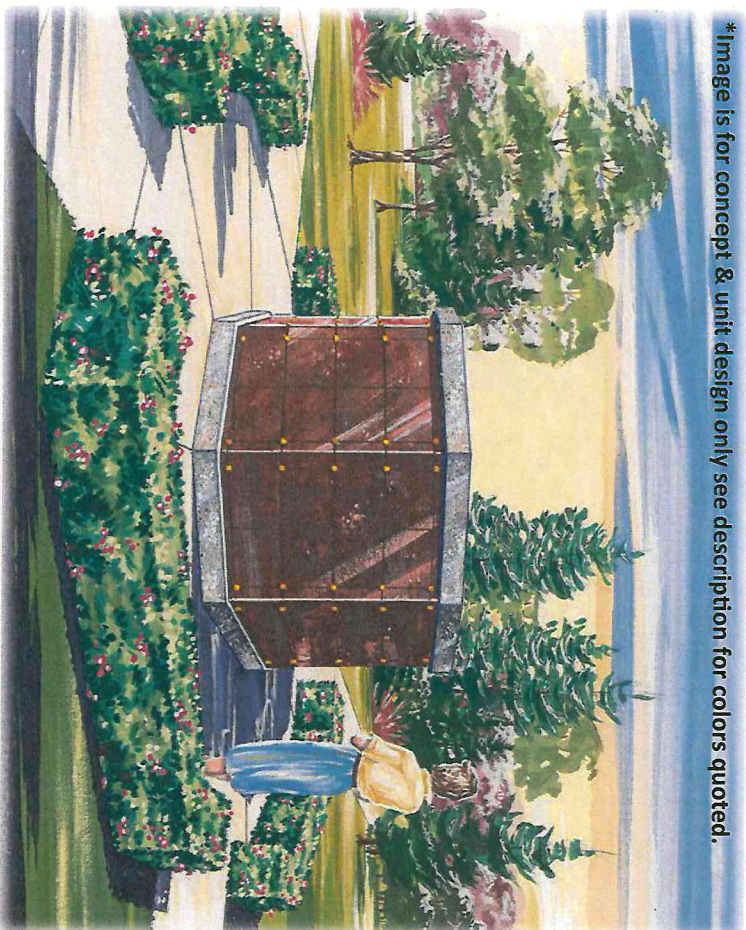

Option 1

4-High Octagon Pre-Assembled Columbarium
Sunset Red Granite Cap and Base
Mesabi Black Granite Niche Fronts

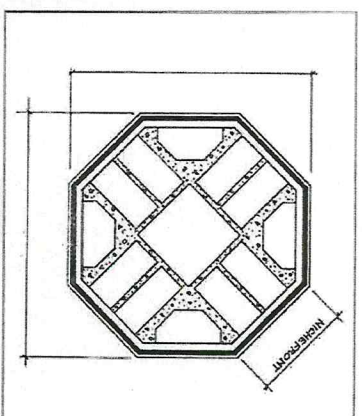

PLAN

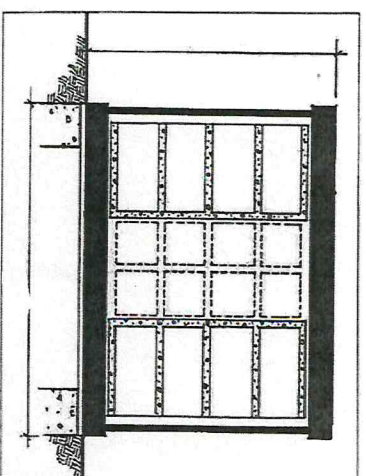

CROSS SECTION

- 4 niches high - 32 double depth spaces and 16 companion side by side spaces allowing the columbarium to hold a total of 96 urns.
- Quarried and Assembled in the USA
- Interior units are reinforced concrete with a durable polystyrene liner and closure. The cabinet is completely clad in granite.
- Niche fronts will be polished (narrow range) Mesabi Black granite and hung with bronze rosette hangers. Each granite front covers two openings.
- Building roof and base will be polished (full range) Sunset Red granite.
- Unit will be shipped preassembled to the site.
- Price includes delivery and installation, but does not include the concrete foundation required under columbarium.
- Purchaser responsible for landscaping.
- Memorialization is not included in this quote but can be provided by Patten Monument at need or pre-need.

*Additional specification available upon request



*Image is for concept & unit design only see description for colors quoted.



Option 2

6-High Octagon Pre-Assembled Columbarium

Sunset Red Granite Cap and Base

Mesabi Black Granite Niche Fronts

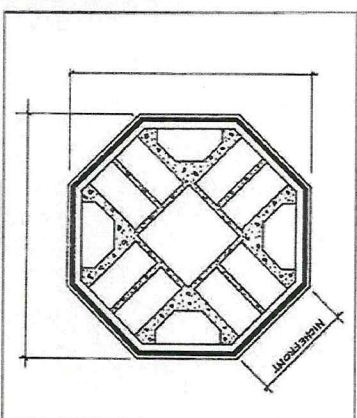
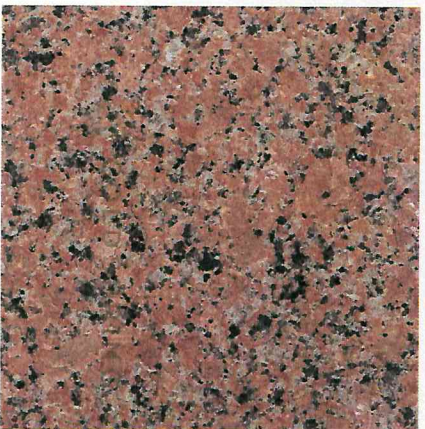

PLAN

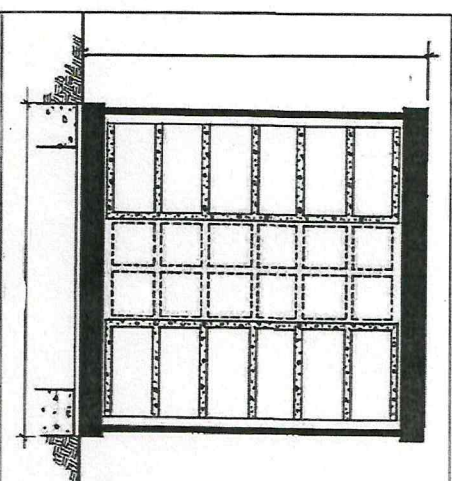

CROSS SECTION

- 6 niches high - 48 double depth spaces and 24 companion side by side spaces allowing the columbarium to hold a total of 144 urns.
- Quarried and Assembled in the USA
- Interior units are reinforced concrete with a durable polystyrene liner and closure. The cabinet is completely clad in granite.
- Niche fronts will be polished (narrow range) Mesabi Black granite and hung with bronze rosette hangers. Each granite front covers two openings.
- Building roof and base will be polished (full range) Sunset Red granite.
- Price includes delivery and installation, but does not include the concrete foundation required under columbarium.
- Unit will be shipped preassembled to the site.
- Purchaser responsible for landscaping.
- Memorialization is not included in this quote but can be provided by Patten Monument at need or pre-need.

*Additional specification available upon request



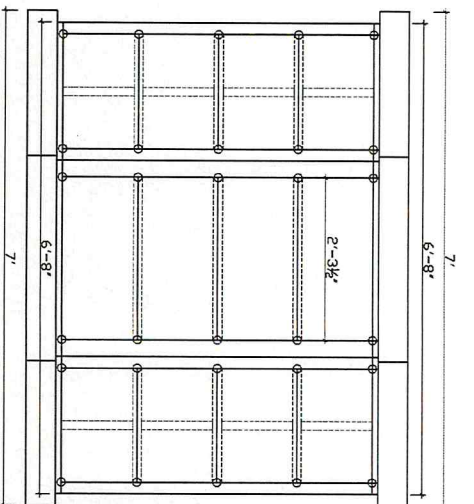
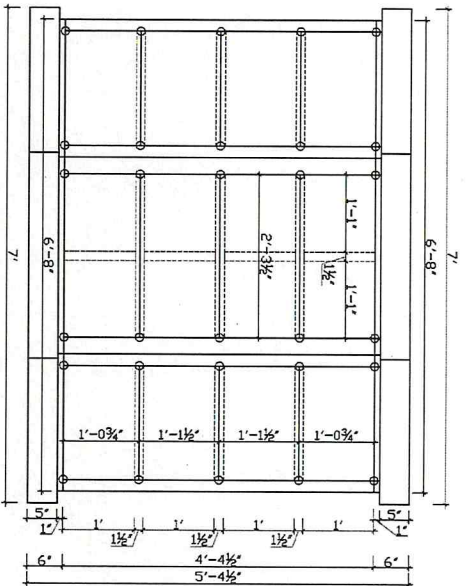
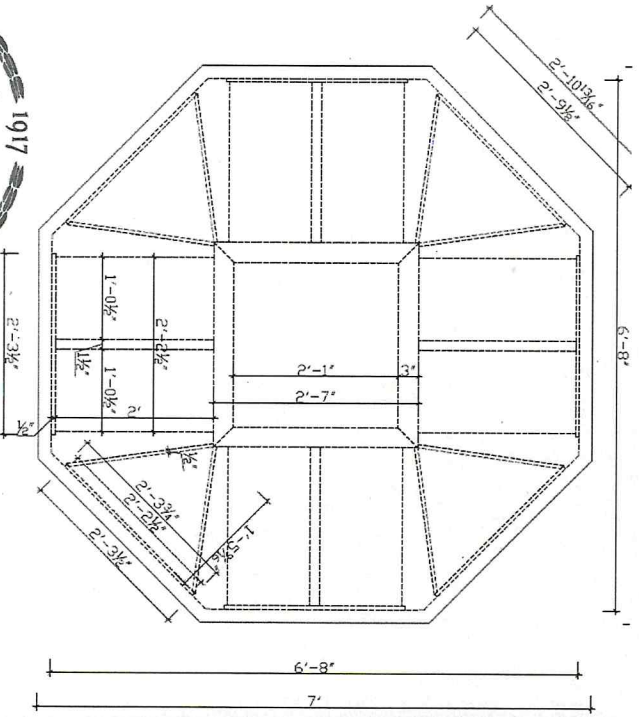
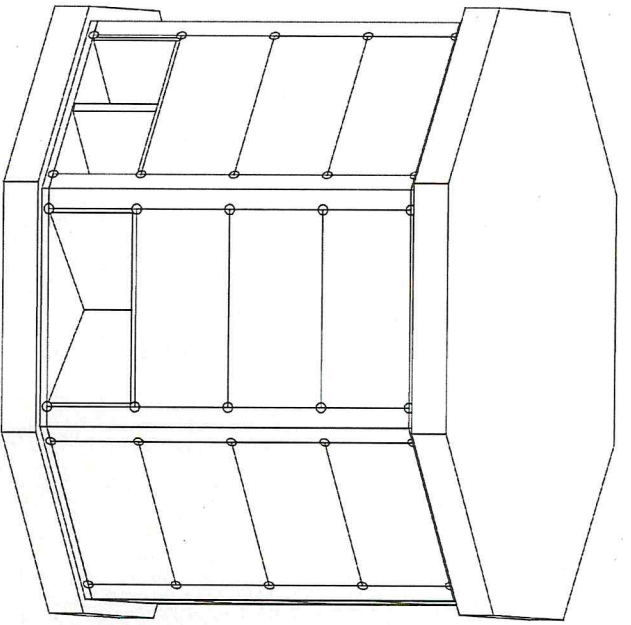

Option 3

4-High Octagon Pre-Assembled Columbarium Oriental Red Cap and Base

with Jet Black Niche Fronts and Supports

- 4 niches high - 32 double depth spaces and 16 companion side by side spaces allowing the columbarium to hold a total of 96 urns.
- Interior walls, shelves, and dividers (not visible from outside) are made of grey granite.
- Niche fronts and exposed vertical supports will be polished Jet Black granite and hung with bronze rosette hangers.
- Building roof and base will be polished (full range) Oriental Red granite.
- Price includes delivery and installation, but does not include the concrete foundation required under columbarium.
- Unit will be shipped preassembled to the site.
- Purchaser responsible for landscaping.
- Memorialization is not included in this quote but can be provided by Patten Monument at need or pre-need.

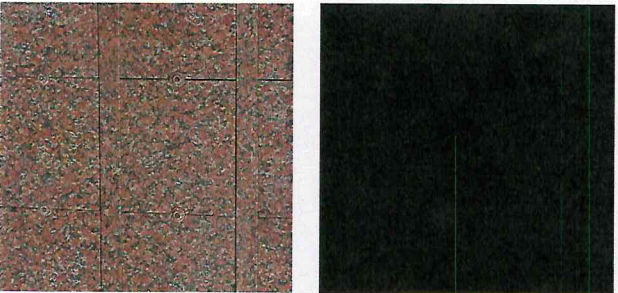

*Additional specification available upon request



*Image is for concept & unit design only see description for colors quoted.

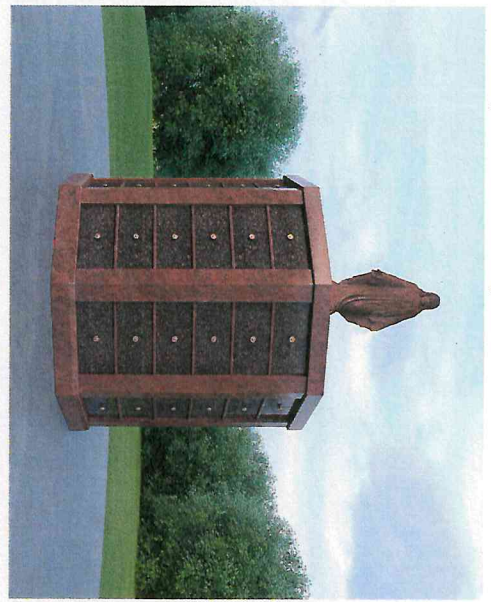

*Quote does not include sculpture on top

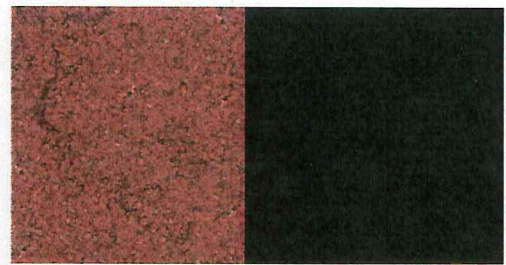
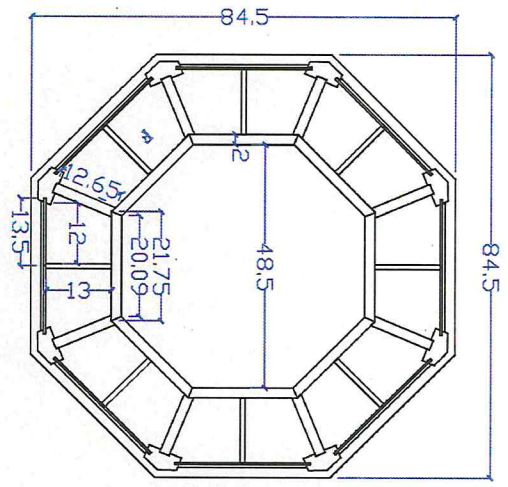

Option 5

7-High Octagon Pre-Assembled Columbarium

112 Single Depth Niche

Multi Color Red Cap, Base, and Supports

with Jet Black Niche Fronts

- 7 niches high - 112 Single Depth Niches Approx. 12" x13" x12"
- Interior walls, shelves, and dividers are made of granite.
- Niche fronts will be polished Jet Black granite and hung with bronze rosette hangers.
- Building roof base and vertical supports will be polished Multicolor Red granite.
- Price includes delivery and installation, but does not include the concrete foundation required under columbarium.
- Unit will be shipped preassembled to the site.
- Purchaser responsible for landscaping.
- Memorialization is not included in this quote but can be provided by Patten Monument at need or pre-need.

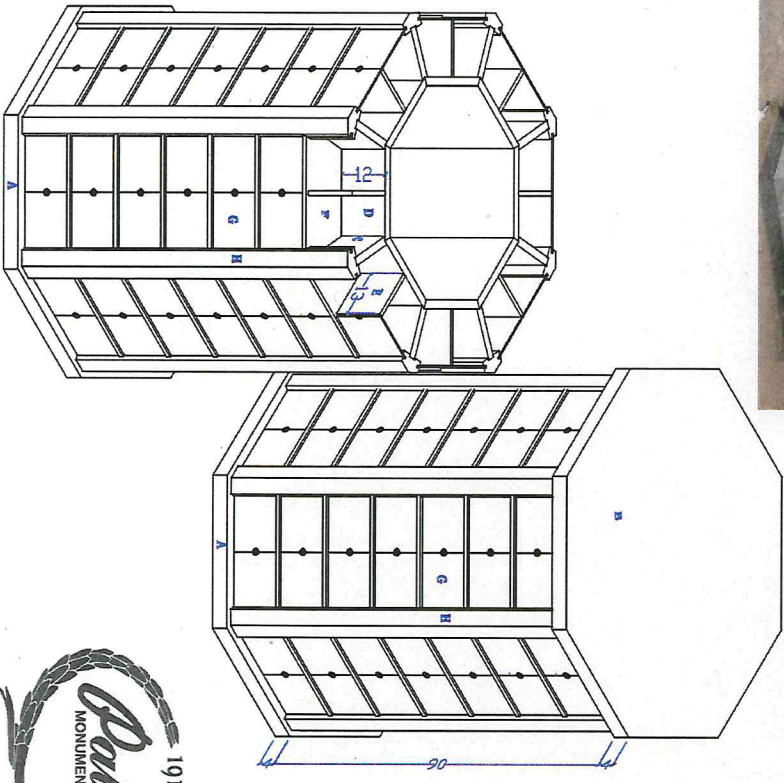

*Additional specification available upon request

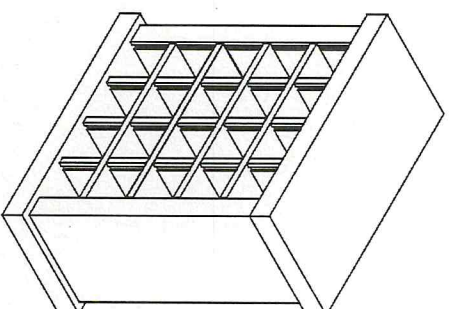
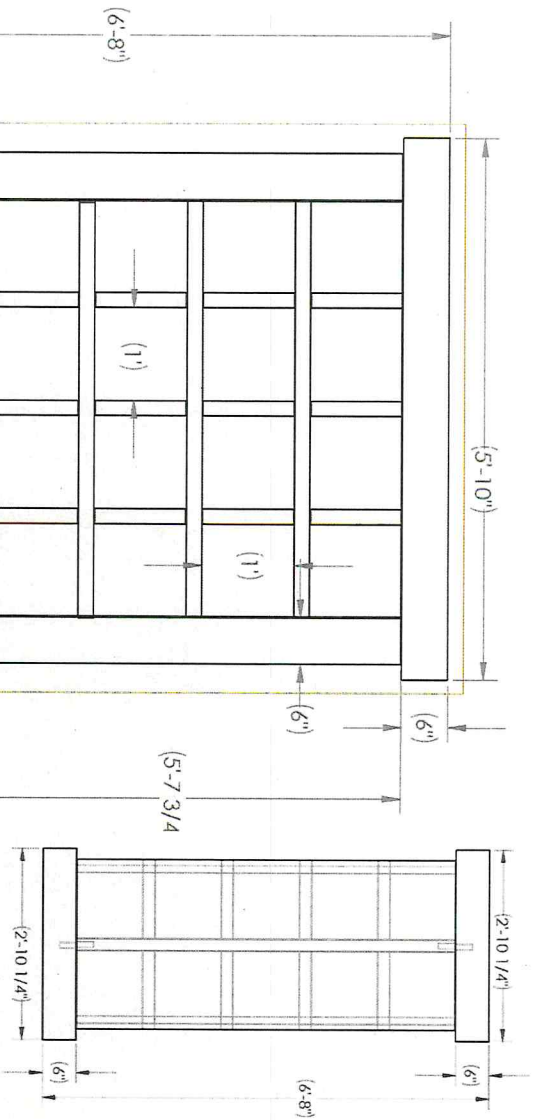

Option 6

5-High Rectangle Pre-Assembled Columbarium 40 Single Depth Niche

Royal Grey Cap, Base, and Supports
with Jet Black Niche Fronts

Same Style Shape Size
and Quarry as the
columbarium currently at
Roseland Cemetery

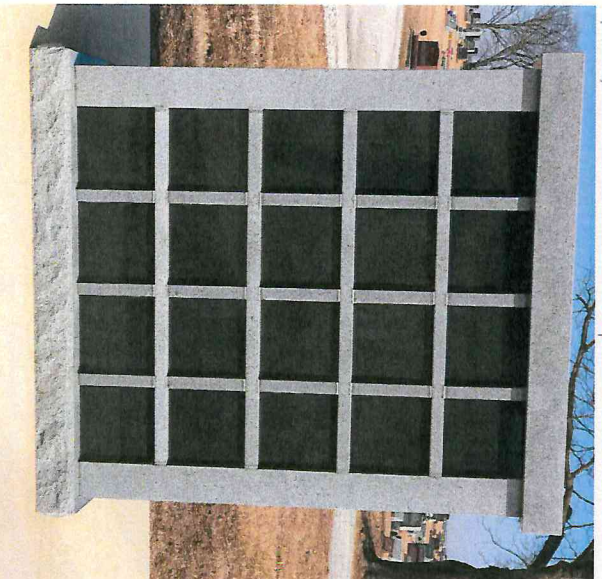

*Additional specification available upon request

- 5 niches high - 40 Single Depth Niches Approx. 12" x13" x12"
- Interior walls, shelves, and dividers are made of granite.
- Niche fronts will be polished Jet Black granite and hung with bronze rosette hangers.
- Building roof base and vertical supports will be polished Royal Grey Granite
- Price includes delivery and installation, but does not include the concrete foundation required under columbarium.
- Unit will fabricated assembled in the US then shipped to location
- Purchaser responsible for landscaping.
- Memorialization is not included in this quote but can be provided by Patten Monument at need or pre-need.





Prices Good for 90 days

For additional specifications please contact:

Jeff Murphy or Alex Fortosis

(jmurphy@pattenmonument.com) (afortosis@pattenmonument.com)

Office Number: 574-267-8933

633 South Buffalo, Warsaw, IN 46580

Option 1: \$ 40,050

4-High Octagon Pre-Assembled Columbarium Sunset Red Granite Cap and Base Mesabi Black Granite Niche Fronts

Option 2: \$ 50,500

6-High Octagon Pre-Assembled Columbarium Sunset Red Granite Cap and Base Mesabi Black Granite Niche Fronts

Option 3: \$ 39,300

4-High Octagon Pre-Assembled Columbarium Oriental Red Cap and Base with Jet Black Niche Fronts and Supports

Option 4: \$ 45,450

5-High Octagon Pre-Assembled Columbarium Oriental Red Cap and Base with Jet Black Niche Fronts and Supports

Option 5: \$ 36,150

7-High Octagon Pre-Assembled Columbarium 112 Single Depth Niche Multi-Color Red Cap, Base, and Supports with Jet Black Niche Fronts

Option 6: \$ 20,750

5-High Rectangle Pre-Assembled Columbarium 40 Single Depth Niche Royal Grey, Base, and Supports with Jet Black Niche Fronts

Future Columbarium Projections for Township Planning

	Option 1	Option 2	Option 3	Option 4	Option 5	Option 6
Urns (Double niches count as 2)	96	144	96	120	112	40
2019 Cost	\$ 40,050	\$ 50,500	\$ 39,300	\$ 45,450	\$ 36,150	\$ 20,750
Cost per urn	\$ 417	\$ 351	\$ 409	\$ 379	\$ 323	\$ 519

	Option 1	Option 2	Option 3	Option 4	Option 5	Option 6
Break Even @\$500 (Urns sold)	80	101	79	91	72	N/A
75% Purchased Total Profit	\$ (4,050.00)	\$ 3,500.00	\$ (3,300.00)	\$ (450.00)	\$ 5,850.00	\$ (5,750.00)
90% Purchased Total Profit	\$ 3,150.00	\$ 14,300.00	\$ 3,900.00	\$ 8,550.00	\$ 14,250.00	\$ (2,750.00)
Total Profit	\$ 7,950.00	\$ 21,500.00	\$ 8,700.00	\$ 14,550.00	\$ 19,850.00	\$ (750.00)

Break Even @\$800 (Urns sold)	50	63	49	57	45	26
75% Purchased Total Profit	\$ 17,550	\$ 35,900	\$ 18,300	\$ 26,550	\$ 31,050	\$ 3,250
90% Purchased Total Profit	\$ 29,070	\$ 53,180	\$ 29,820	\$ 40,950	\$ 44,490	\$ 8,050
Total Profit	\$ 36,750	\$ 64,700	\$ 37,500	\$ 50,550	\$ 53,450	\$ 11,250

Break Even @\$1000 (Urns sold)	40	51	39	45	36	21
75% Purchased Total Profit	\$ 31,950	\$ 57,500	\$ 32,700	\$ 44,550	\$ 47,850	\$ 9,250
90% Purchased Total Profit	\$ 46,350	\$ 79,100	\$ 47,100	\$ 62,550	\$ 64,650	\$ 15,250
Total Profit	\$ 55,950	\$ 93,500	\$ 56,700	\$ 74,550	\$ 75,850	\$ 19,250

Break Even @\$1300 (Urns sold)	31	39	30	35	28	16
75% Purchased Total Profit	\$ 53,550	\$ 89,900	\$ 54,300	\$ 71,550	\$ 73,050	\$ 18,250
90% Purchased Total Profit	\$ 72,270	\$ 117,980	\$ 73,020	\$ 94,950	\$ 94,890	\$ 26,050
Total Profit	\$ 84,750	\$ 136,700	\$ 85,500	\$ 110,550	\$ 109,450	\$ 31,250

	Forecast of Columbarium Costs					
	Option 1	Option 2	Option 3	Option 4	Option 5	Option 6
2024 Estimate	\$ 44,819	\$ 56,318	\$ 43,949	\$ 50,781	\$ 40,384	\$ 23,219
Cost per urn	\$ 467	\$ 391	\$ 458	\$ 423	\$ 361	\$ 580
2029 Estimate	\$ 50,273	\$ 62,958	\$ 49,265	\$ 56,872	\$ 45,224	\$ 26,047
Cost per urn	\$ 524	\$ 437	\$ 513	\$ 474	\$ 404	\$ 651
2039 Estimate	\$ 63,677	\$ 79,223	\$ 62,323	\$ 71,819	\$ 57,102	\$ 33,009
Cost per urn	\$ 663	\$ 550	\$ 649	\$ 598	\$ 510	\$ 825

Estimates cannot be perfectly predicted, these numbers reflect general trends in the market and economy.
 Cost Projections do not include any additional cost the purchaser may incur. Foundation, Landscaping, Niche Engraving Ect.

